

# SETTOP neptune

## SOFTWARE FOR MARITIME WORKS

CAISSON BOX  
POSITIONING  
SYSTEM

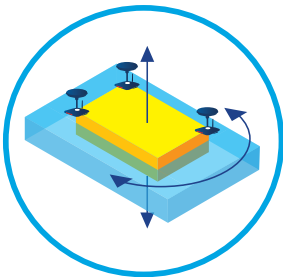

BATHYMETRIC  
CONTROL  
SYSTEM

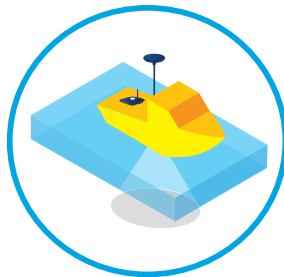

HOPPER BARGE  
CONTROL  
SYSTEM

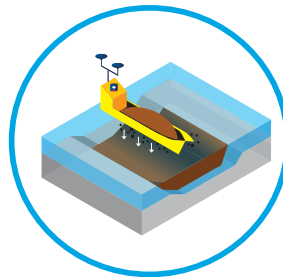

CONCRETE BLOCK  
POSITIONING  
SYSTEM

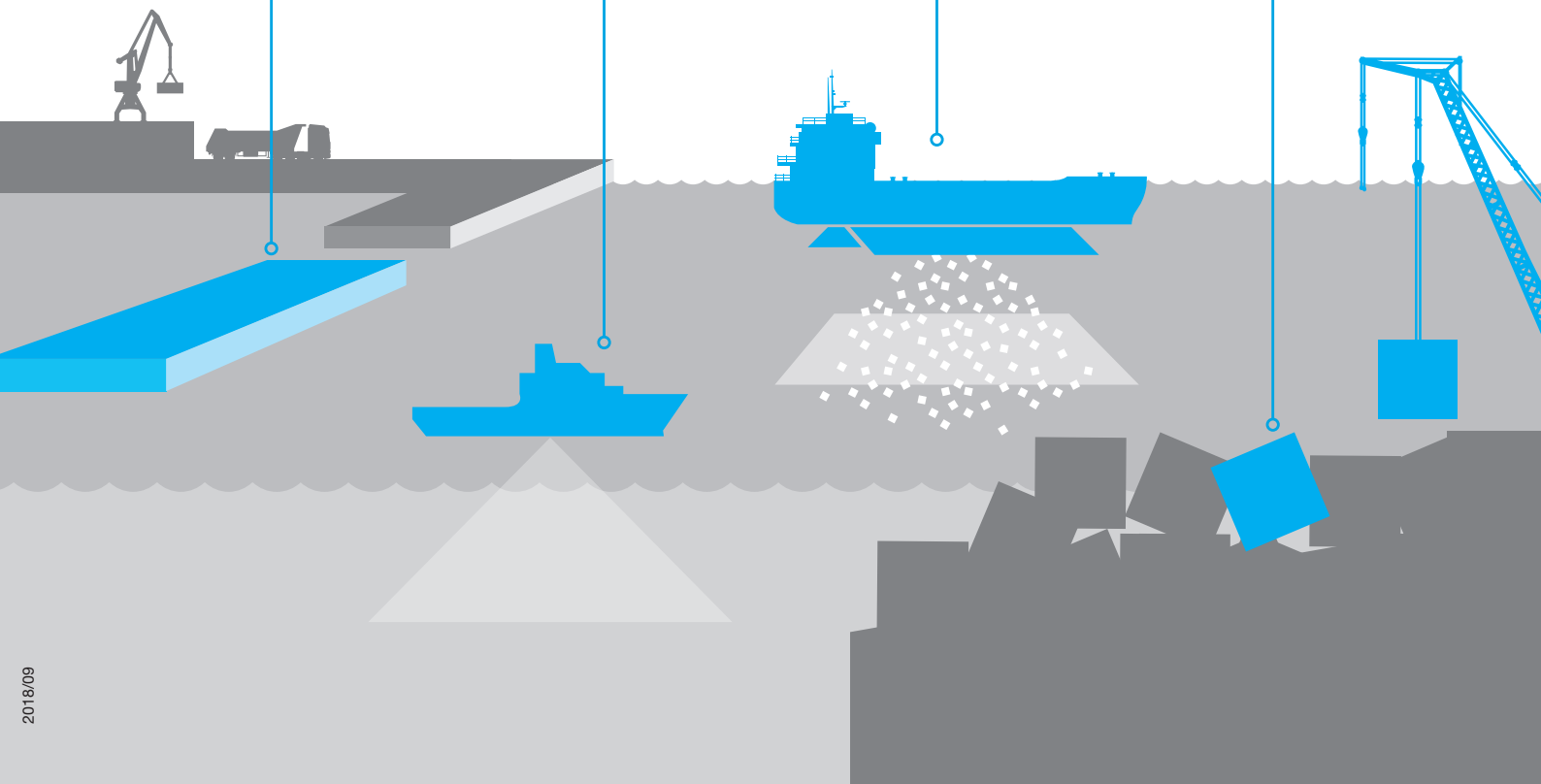
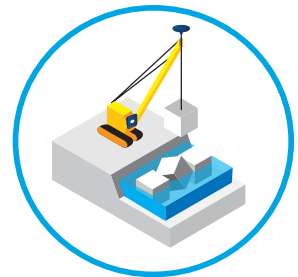



# SETTOP NEPTUNE SOLUTIONS FOR MARITIME WORKS

The SettopSurvey team has more than 25 years of experience providing the best solutions to practical problems in maritime works at the express request of our customers.

We supply a wide range of products from monitoring and topographic sensing to bathymeters, positioning of caisson boxes, of concrete blocks for dykes, and control systems for hopper barges in dredging works.

The SettopSurvey team will help you to find the most adequate and optimal solution to tackle any problem that might arise in maritime works.

The systems that SettopSurvey offers are divided into two blocks:

- Guided and control systems for construction elements
- Measuring and data gathering systems for the later generation of digital models of land surface and diverse other studies.

**SETTOP**



## INDEX

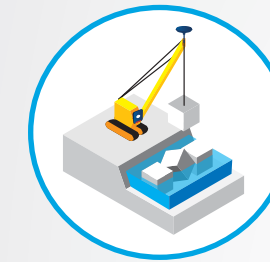

**SETTOP  
NEPTUNE CRANE**  
CONCRETE BLOCK  
POSITIONING  
SOLUTION

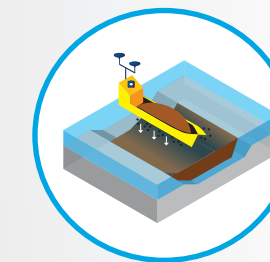

**SETTOP  
NEPTUNE BOAT**  
HOPPER BARGE  
CONTROL  
SOLUTION

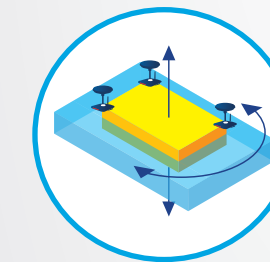

**SETTOP  
NEPTUNE CASE**  
SYSTEM FOR  
POSITIONING OF  
FLOATING CONCRETE  
CAISSONS



**BATHYMETRY**  
BATHYMETRIC CONTROL  
SYSTEM



# SETTOP NEPTUNE CRANE CONCRETE BLOCK POSITIONING SOLUTION

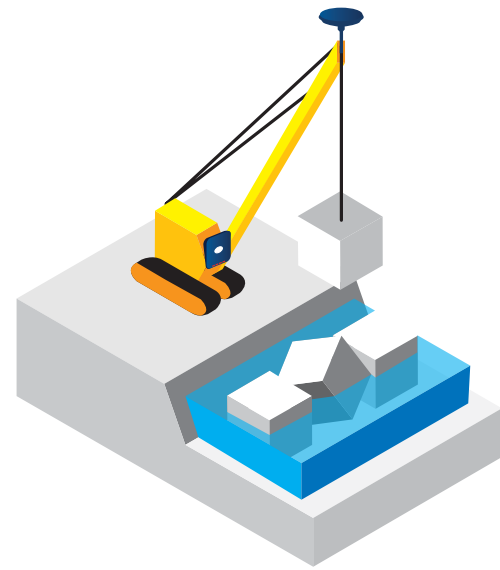

## WHAT IS IT?

We can define blocks as singular elements, whether they are concrete cubes or of some other shape, which are used in the construction of rubble mound breakwaters or concrete piles for the construction of pile supported wharves. The accurate positioning of these elements in the exact space required is of vital importance for maintaining the correct geometrical structure of any maritime works project.



## MAIN ADVANTAGES

- Compact system
- RTK Solution (centimetric precision)
- Antenna tilt system
- Compatible with all types of cranes
- Easy to use software
- Easy project configuration
- Visualization of seabed mapping
- Odometer option (wireline counter)
- Option of antenna orientation

## WHAT SOLUTION DO WE OFFER?

SettopSurvey offers you the ideal solution for high precision guidance for the placement of blocks in dykes.

Through the use of SettopSurvey's advanced positioning system, the crane operator will be able to place each block in position with total precision. Also, with its continuous localization system, and thanks to its practical visualizer, the crane operator will know the exact position of the block at all times and be able to place it with absolute precision in relation to the project drawings and descriptions.

Its centimetric positioning system is based on a GNSS receiver\*, a reception antenna, and software connected to a tablet or computer. If the project requires you to know the depth at which the blocks are to be released, you can use an odometer to measure the route of the cable. Also, you can use a second antenna which lets you know the direction of the arm of the crane.

1

Guided construction of dykes

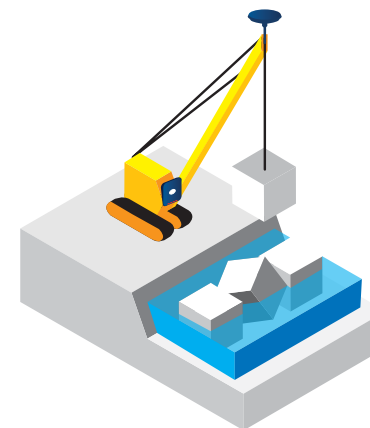

2

Guided construction of pile supported wharves

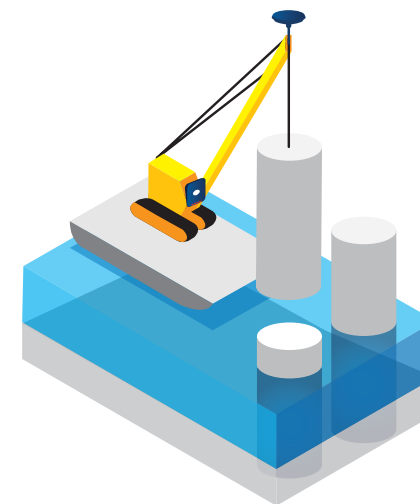

\* Check the compatibility with other GNSS receivers.

## NEPTUNE CRANE SOFTWARE (Block Positioning System)

The software, specifically designed for controlling the positioning of blocks for dykes, has various diverse functionalities available depending on the needs of the user, for example the possibility of working with just one GNSS receiver or with two... The software allows you to register the location of the blocks, guide their placement, and even record the route followed by the block until it is in place. With the topographic mapping of the sea bed, guiding and placement of blocks becomes extraordinarily easy.

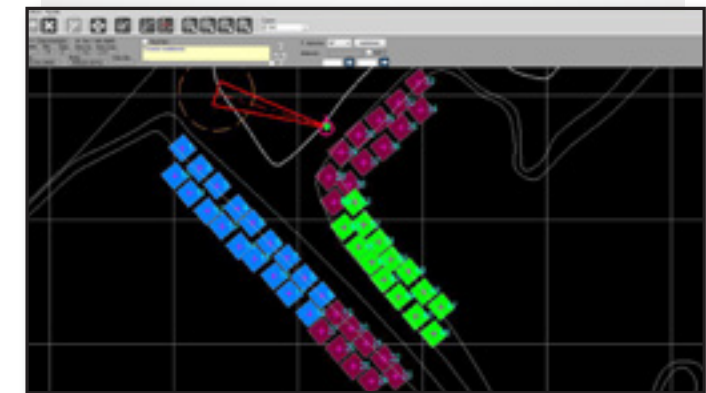

## COMPONENTS



- Compatible GNSS receiver\*
- GNSS antenna
- PC or tablet
- Communication cables
- Control software

### Optional Components

- GNSS orientation antenna
- Cable counter
- Land positioning system
  - Compatible GNSS receiver (Base)
  - Radio
  - Power sources



# SETTOP NEPTUNE BOAT HOPPER BARGE CONTROL SOLUTION

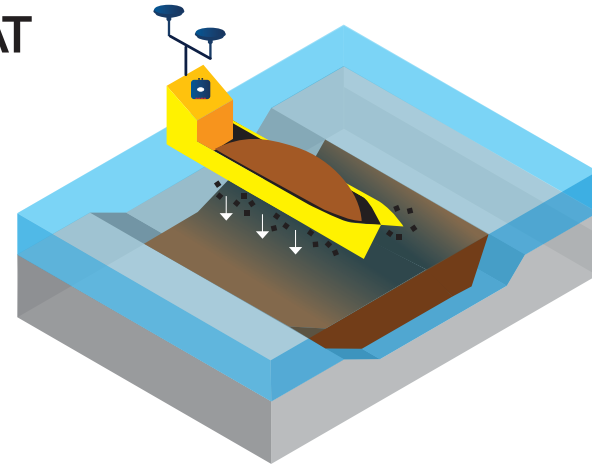

## WHAT IS IT?

The hopper or split hopper barge is a flat vessel with the bow and stern of the same shape used for dumping granular material in the sea. It is made up of a steel float, normally peripheral, and has a bottom with doors which open up and dump the contents into the water using the force of gravity. One of its main tasks is to dump material to fill a specific site in the sea.



## MAIN ADVANTAGES

- Compact system
- RTK solution (centimetric precision) or DGPS (submetric precision)
- Double antenna
- Easy to use software
- Easy project configuration
- Visualization of seabed mapping

## WHAT SOLUTION DO WE OFFER?

SettopSurvey has developed an integrated system which allows you to see the location of a vessel in a simple graphical environment. Controlling where the dumping is to be carried out becomes a very easy task with the System proposed by SettopSurvey. The receiver\* with a double antenna allows you to obtain the course of the vessel as well as a precise position with one of the antennas.

The system allows you to work in DGPS mode (<1m) or in RTK mode (centimetric)

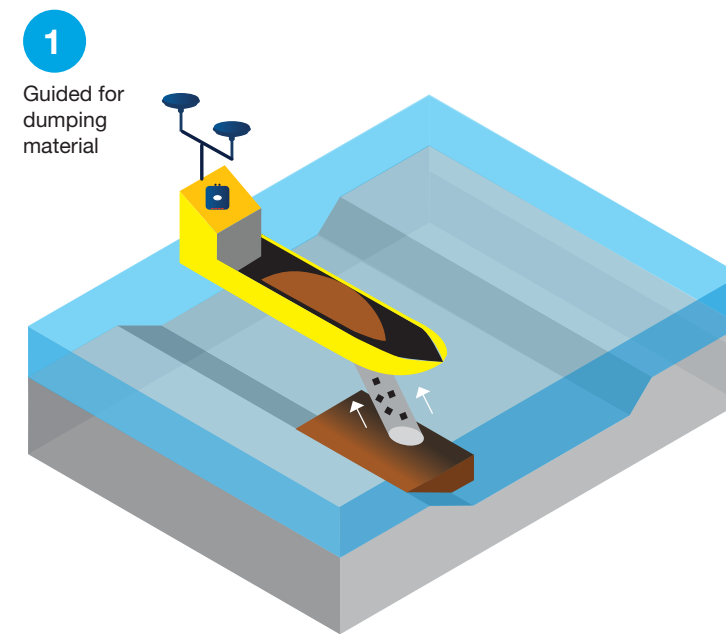

\* Check the compatibility with other GNSS receivers.

## NEPTUNE BOAT SOFTWARE (Split Hopper Barge)

The guided software for dumping is based on the barge's loading capacity. The double antenna GPS will indicate the orientation of the vessel in a highly visual and graphical way which will allow you to mark the cells where you have dumped material in order to optimize the work in a far better and more efficient way. The fact that you can also load a map of the seabed without needing specific CAD software greatly reduces the complexity of the project and makes it a lot easier to carry out.

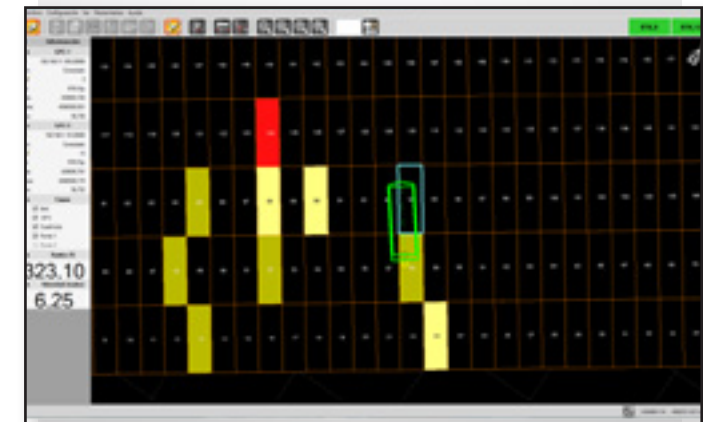

## COMPONENTS

- |   |   |   |
|---|---|---|
|  |  |  |
| • Compatible GNSS receiver*   | • 2 GNSS antennas<br>• Communication cables   | • PC or tablet<br>• Control software  |

### Optional Components

- Land positioning system
  - Compatible GNSS receiver (Base)
  - Radio
  - Power sources



# SETTOP NEPTUNE CASE SYSTEM FOR POSITIONING OF FLOATING CONCRETE CAISSONS

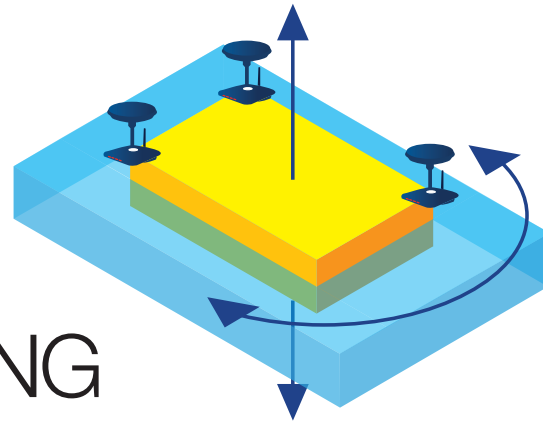

## WHAT IS IT?

We can define caissons as concrete platforms designed and built for the construction of dykes, wharves, and other port works. They may in fact be the largest prefabricated concrete pieces in use as they can reach dimensions of up to 70x40x45m. Concrete caissons are transported on floats from their place of construction to their destination, which could be many miles away.



## MAIN ADVANTAGES

- Compact system
- RTK solution (centimetric precision)
- Easy to use software integrated in the system
- Easy project configuration
- Visualization of seabed mapping



## WHAT SOLUTION DO WE OFFER?

The system proposed by SettopSurvey guides you in a simple and straightforward way through the process of towing the caisson to the work area, the exact positioning of the caisson in relation to the project, and checks that everything is correct once the caissons are anchored in place.

For the whole process you only need the positioning system\*, together with 3 GNSS antennas and control software installed on a computer or tablet. The software will indicate at all times the location of the caisson and the values associated to each one, such as the alignment, balance and pitch. In the software you can load a map of the seabed so that the operator can identify and interpret the location of the caisson in an easy and quick way. All of the values given have a centimetric precision.

In the system\* are included multiple communication systems (modem, radio, Wi-Fi) which allow you to obtain differential corrections for purposes of precision through internet or radio.

**1**  
Guide of the towing process

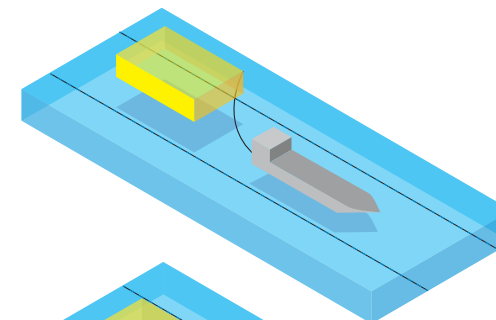

**2**  
Guide for positioning

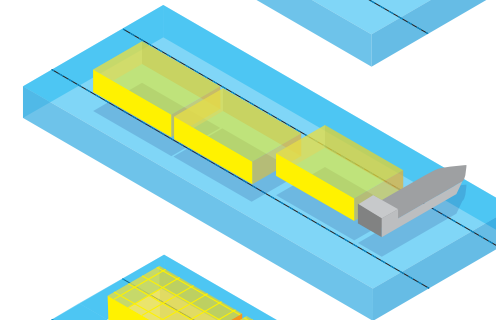

**3**  
Anchoring check

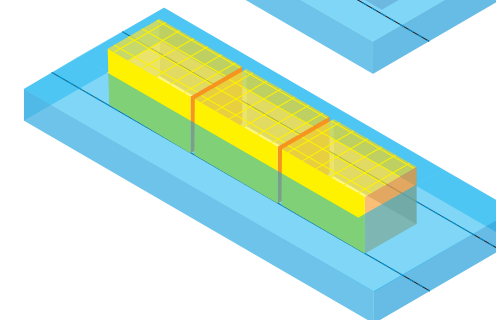

\* Check the compatibility with other GNSS receivers.

## NEPTUNE CASE SOFTWARE (3D Floating Concrete Blocks)

Software developed by the SettopSurvey team in which you can activate the reception of data from up to 3 GNSS receivers\* and via which you can control the location of the floating block at all times for its correct placement. The possibility of loading a map of the seabed makes the guiding operation very easy and also supplies the user with all the necessary information for a successful completion of the project.

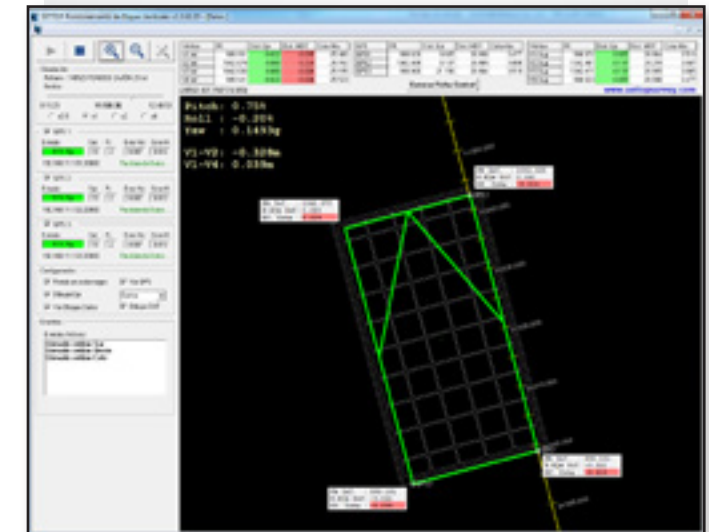

## COMPONENTS



- Compatible GNSS receiver\*
- 3 GNSS antennas
- PC or tablet
- Communication cables
- Control software

### Optional Components

- Land positioning system
  - Compatible GNSS receiver (Base)
  - Radio
  - Power sources



# BATHYMETRY BATHYMETRIC CONTROL SYSTEM

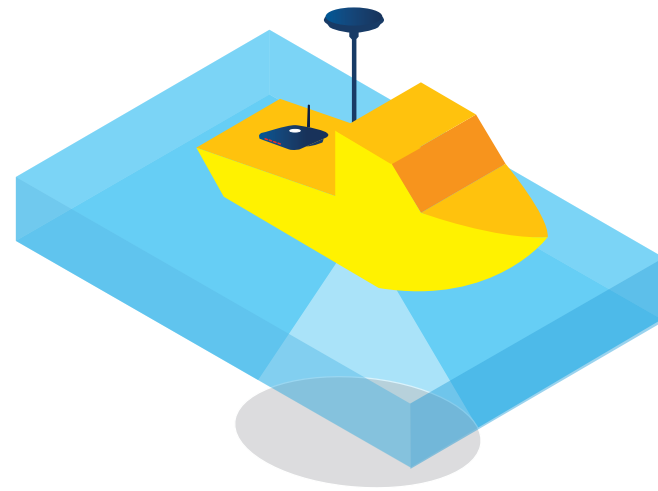

## WHAT IS IT?

We understand bathymetry as the surveying of the relief of underwater surfaces; what we are speaking of here is the bottom of the sea, water courses, lakes, and reservoirs. It is the mapping and surveying of the bottom of underwater surfaces just as if we were on dry land. As in conventional surveys, we find the co-ordinates X, Y, and Z so that we can accurately describe the underwater depths and all the anomalies and exceptions that they can present for the topographer.



## MAIN ADVANTAGES

### GNSS Receivers

- Compact system
- External GNSS antenna
- RTK solution (centimetric precision)
- PPS output
- Compatible with all echo sounders

### Single beam echo sounder

- Ultra-compact system (less than 1kg)
- Compatible with most GNSS receivers on the market
- Use of its own GNSS team software
- Minimum installation
- Measuring range of up to 75m
- Perfect for small areas or reservoirs

## WHAT SOLUTION DO WE OFFER?

With the aim of providing a solution for every aspect of your business, SettopSurvey offers you various products designed to fit all of your needs:

- A GPS receiver\* with PPS output for the synchronization of data with a single beam or multibeam echo sounder to guarantee centimetric precision
- EU400 echo sounder, an ultra-compact single beam echo sounder which will allow you to carry out maritime works and work in rivers and reservoirs without high investment costs and you will be able to connect directly to your GNSS receiver through a USB connector.

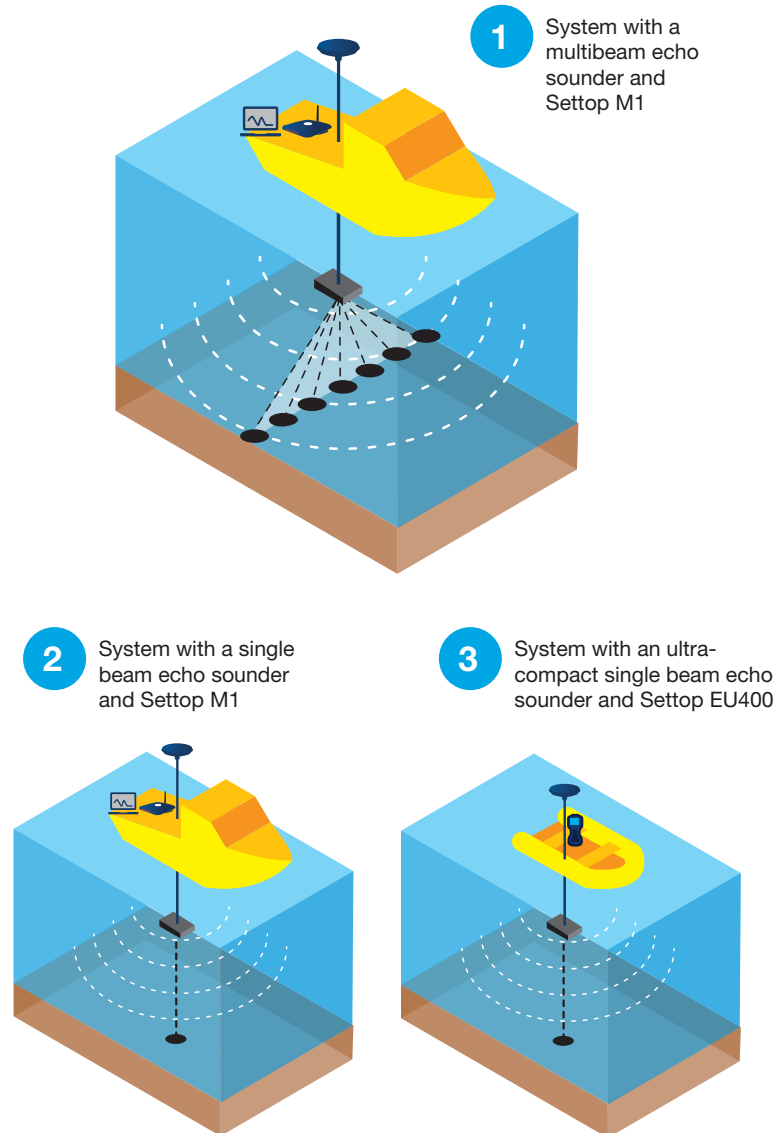

\* Check the compatibility with other GNSS receivers.

## HYDROGRAPHIC SOFTWARE

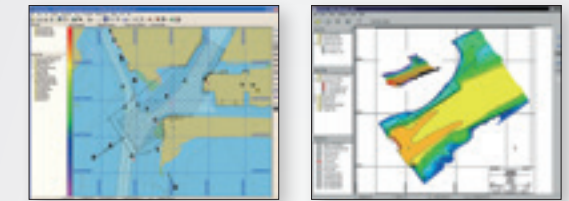

Hydrographic software compatible with HYPACK

## COMPONENTS

### BATHYMETRIC SYSTEM WITH COMPATIBLE GNSS RECEIVER\*



- Compatible GNSS receiver\*
- EU400 single beam echo sounder with transducer
- EU400 communication box



- 1 GNSS antenna
- Communication cables
- Control software

### BATHYMETRIC SYSTEM WITH SETTOP EU400

#### Basic components for single beam echo sounder

- EU400 single beam echo sounder with transducer included
- EU400 communication box

#### Compatible components for single beam echo sounder

- Trimble GNSS receiver
- Trimble tablet or Trimble TSC3 with software

**SETTOP**  
**neptune**

**SOFTWARE FOR  
MARITIME WORKS**